

Varenummer: 03449070
 Beskrivelse: Fluro Heavy Duty Ledleje GE 70 SWE
 Hul Ø70
 Note: 70

Mål

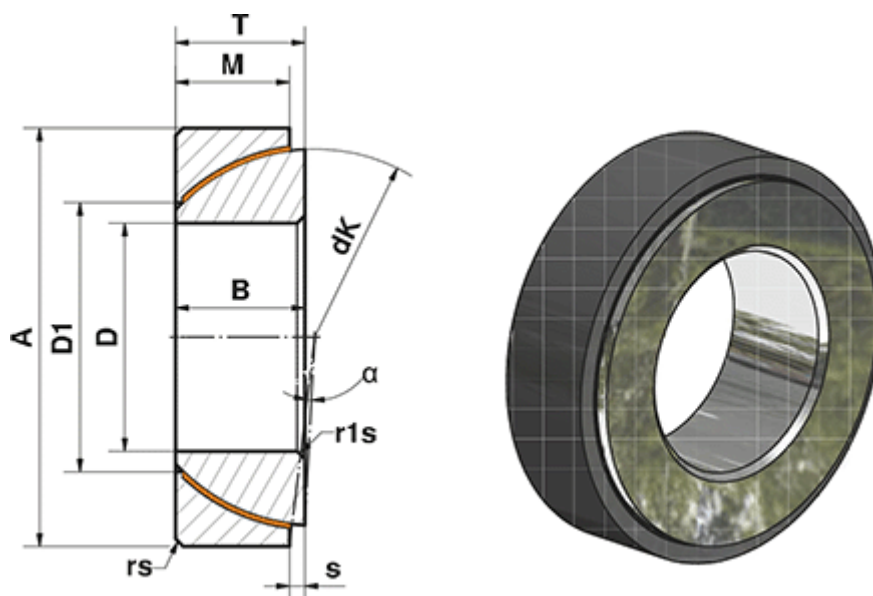

A	= 110	rs, r1s min	= 1.1
a (grader)	= 2	S	= 7.2
B	= 25	Statisk belastning C0 (kN)	= 972
D	= 70	T	= 25
D1	= 82.6	Vægt (g)	= 1040
dK	= 102		
Dynamisk belastning C (kN)	= 583		
M	= 23		